

Master Pricing Index Indice De Fixation Des Prix

NTP-1109

**NELSON FIRESTOP PRODUCTS
PRODUITS FIRESTOP DE NELSON**

Effective November 1, 2009.
En Vigueur le 1^{er} novembre, 2009.

Suggested Trade Price Index
Tax Not Included
*Indice des prix marchands suggérés
Tax non incluse*

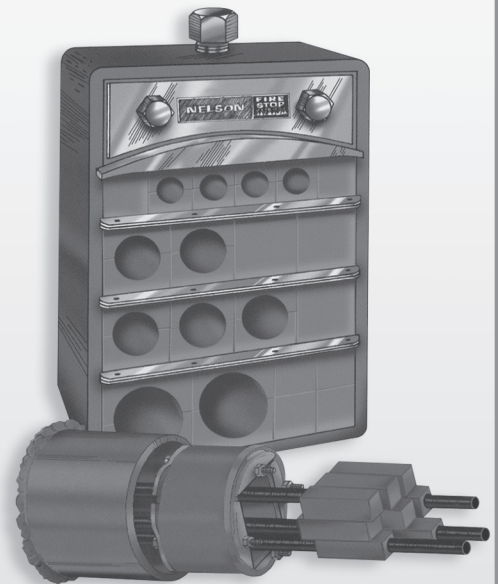
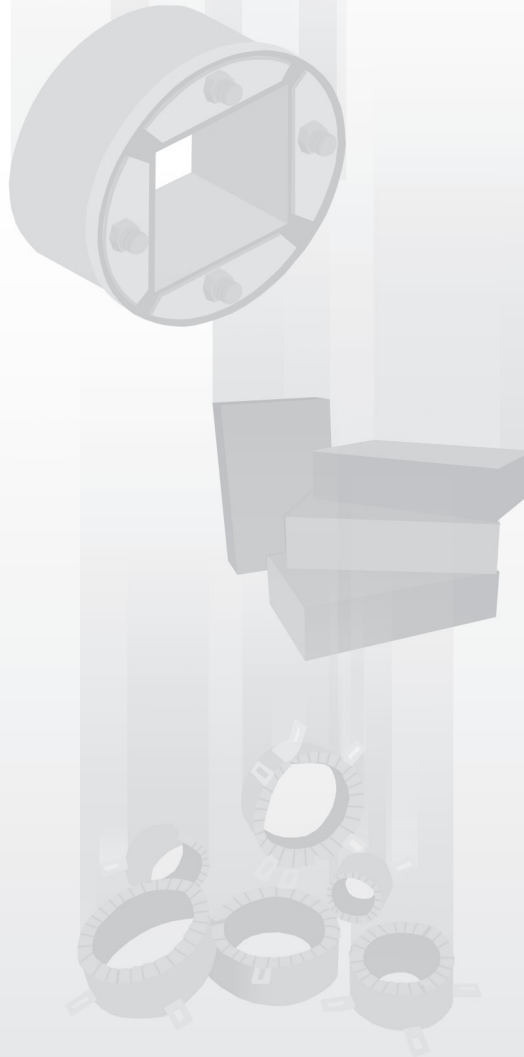

Distributed by:
Distribue par:

NELSON

EMERSON
Industrial Automation

NTP-1109 supercedes and cancels all previous pricing indexes and their supplements.
L'indice de fixation des prix NTP-1109 remplace tous les indices anterieurs et leurs supplements.

TERMS AND CONDITIONS OF SALE**1. Price Changes**

Prices in the Price List are correct and up to date. If prices change, an Addendum to the current Price List or an entire new Price List will be issued. Prices and additional information are compiled with care but obviously cannot be guaranteed and are subject to change without notice. Clerical errors are subject to correction.

2. Warranty-Disclaimer of Warranties

Products of EGS Electrical Group Canada Ltd. are warranted against defects of material and workmanship under normal and proper use and service for a period of one year from date of shipment from factory.

THERE ARE NO EXPRESS WARRANTIES OR WARRANTIES OF FITNESS FOR ANY PARTICULAR PURPOSE, OR ANY IMPLIED WARRANTIES OTHER THAN THOSE MADE EXPRESSLY HEREIN.

THE FOREGOING WARRANTY IS EXCLUSIVE AND IN LIEU OF ALL OTHER REPRESENTATIONS AND EXPRESSED OR IMPLIED WARRANTIES. THE PARTIES AGREE THAT THE IMPLIED WARRANTIES OF MERCHANTABILITY AND FITNESS FOR A PARTICULAR PURPOSE ARE EXCLUDED FROM THIS TRANSACTION AND SHALL NOT APPLY TO GOODS SOLD.

EGS Electrical Group Canada Ltd. assumes no responsibility for the application, proper selection or installation of its products. The remedies provided for in this warranty are limited to the furnishing of new parts free of charge in exchange for parts which have proven defective. Expenses incurred in repairing or replacing any defective part, or any expenses resulting from consequential damages will not be allowed.

3. Delivery Terms on Shipments Direct to Distributor's Customers

Shipments of orders shipped direct to the Distributor's customer, are shipped F.O.B. Shipping Point, with transportation pre-paid, cheapest way to any Distributor's city in Canada (except Yukon and North West Territories) on all orders having a value of \$3500 or more, excluding Poles. No freight allowed on orders less than \$3500.00 Trade Price Value. An assortment of EGS Electrical Group Canada Ltd. products is permitted to determine the total value for one order, excluding Poles.

Express, Air Express and Air Freight, etc. shipments shipped direct to the Distributor's customer are F.O.B. Shipping Point, freight collect. Upon request such shipments will be made prepaid and charge with the transportation added to the Invoice.

Cartage

EGS Electrical Group Canada Ltd. will not assume, allow or pay any special notification charges assessed by the carrier or any charges for cartage, detention, or store door delivery at destination.

Claim for Shortages

No claim for shortages will be recognized by EGS Electrical Group Canada Ltd. unless such shortage is reported to the Home Office of EGS Electrical Group Canada Ltd., Cambridge, Ontario within fifteen days after receipt of shipment at destination.

4. Prices

Prices listed are Trade Net. Tax is not included.

CONDITIONS DE VENTE DU FOURNISSEUR

1. Changements des prix

Les prix reflétés dans cette liste sont exacts et courants. En cas de changement, un addenda à la liste des prix courants, ou encore une nouvelle liste, sera émise. Les prix et tous les renseignements supplémentaires sont compilés avec soin, mais ne peuvent être garantis et sont sujets à modification sans préavis. Les erreurs d'écritures sont sujettes à correction.

2. Garantie

EGS Electrical Group Canada Ltd. garantit ses produits contre les vices de fabrication ou de matières premières dans les conditions normales et appropriées d'utilisation et de service pendant un an à partir de la date d'expédition de l'usine. Il n'y a aucune garantie expresse ni garantie d'adaptation à une fin particulière ni aucune garantie implicite autre que celles données expressément dans la présent.

La garantie précitée est exclusive et remplace toutes les autres représentations et garanties expresses et implicites. Les parties acceptent que les garanties implicites de qualité loyale et marchande et d'adaptation à une fin particulière soient exclues de cette transaction et qu'elles ne doivent pas s'appliquer aux biens vendus.

EGS Electrical Group Canada Ltd. n'assume aucune responsabilité pour l'utilisation, le bon choix ou l'installation de ses produits. Les dédommagements prévus dans cette garantie sont restreints à la fourniture de nouvelles pièces, sans frais, pour remplacer celles qui se sont avérées défectueuses. Les frais encourus pour réparer ou remplacer une pièce défectueuse ou tous les frais encourus à la suite de dommages indirects ne seront pas autorisés.

3. Modalités d'expédition directe aux clients du distributeur

Les marchandises expédiées directement aux clients du distributeur le sont F.A.B. point d'expédition, avec frais de transport payés pour le mode le moins coûteux vers toute ville canadienne du distributeur (sauf le Yukon et les Territoires du Nord-Ouest) pour toutes les commandes d'une valeur marchande de 3500 \$ ou plus. Aucun transport n'est prévu pour les commandes d'une valeur marchande inférieure à 3500 \$. Il est possible d'utiliser un assortiment de produits EGS Electrical Group Canada Ltd. pour déterminer la valeur globale d'une commande.

Les marchandises expédiées directement par express, express aérien, fret aérien, etc., au client du distributeur le sont F.A.B. point d'expédition, transport dû. Sur demande, de telles expéditions seront prépayées et les frais de transport ajoutés à la facture.

Camionnage

EGS Electrical Group Canada Ltd. n'assumera, ne prévoiera ni ne paiera aucun frais de notification spéciale prévue par le transporteur ni aucun frais de camionnage, d'entreposage ou de livraison au magasin à destination.

Réclamation pour commandes incomplètes

EGS Electrical Group Canada Ltd. ne reconnaît aucune réclamation pour commandes incomplètes à moins que la dite commande incomplète ne soit signalée au siège sociale d'EGS Electrical Group Canada Ltd., CAMBRIDGE (Ontario), dans les quinze jours suivant la réception des marchandises à destination.

4. Prix

Les prix reflétés sont les prix marchands nets. Taxes non incluse.

NELSON

Pricing Information

EGS Canada Trade Price List

NOTE: Must Order By Standard Package Quantities Only.



Part Number	Description	Product Type	Unit Size	Std. Pkg. Quantities	Std. Pkg. Weight	UPC Code 8349900+	Trade CAD Per Each
Silicone Sealant – CLK™							
AA529	Silicone - Non Sag	CLK™	304 ml	12 Tubes in	5.44 kg	05291	23.50
AA596	Silicone - Non Sag	CLK™	887ml	10 Tubes in	1 2.25 kg	05963	57.50
AA542	Silicone - Non Sag	CLK™	7.6 l	1 Pail	1 0.88 kg	05420	354.25
AA492	Silicone - Non Sag	CLK™	17.0 l	1 Pail	27.22 kg	04928	734.00
AA539	Silicone - Self Leveling	CLK™	304 ml	12 Tubes in	5.44 kg	05390	22.50
AA552	Silicone - Self Leveling	CLK™	17.0 l	1 Pail	27.22 kg	05529	734.00
Latex Sealant – LBS3™							
AA0892	Latex Sealant	LBS3™	304 ml	12 Tubes	5.44 kg	08926	21.25
AA0893	Latex Sealant	LBS3™	597 ml	12 Packs	1 0.89 kg	08933	40.50
AA0894	Latex Sealant	LBS3™	887ml	10 Tubes	1 2.25 kg	08940	47.00
AA0895	Latex Sealant	LBS3™	18.9 l	1 Pail	27.22 kg	08957	660.50
Elastomeric Sealant – ES1399™							
AA0870	Elastomeric Sealant - Non Sag	ES1399™	304 ml	12 Tubes	5.44 kg	08704	19.25
AA0874	Elastomeric Sealant - Non Sag	ES1399™	597 ml	12 Packs	10.89 kg	08742	37.25
AA0890	Elastomeric Sealant - Non Sag	ES1399™	887 ml	10 Tubes	12.25 kg	08902	43.75
AA0871	Elastomeric Sealant - Non Sag	ES1399™	18.9 l	1 Pail	27.22 kg	08711	623.50
Firestop Joint Coating – FSC3™							
FSC3	Joint Coating	FSC3™	18.9 l	1 Pail	22.68 kg	08681	488.50
Firestop Putty – FSP™							
AA445	Firestop Putty - Bar	FSP™	25mm x 75mm x 300mm	10 Bars	8.16 kg	04454	40.50
AA0439	Firestop Putty - Carton	FSP™	125mm x 250mm x 250mm	9.07 kg	9.07 kg	04393	399.00
AA458	Firestop Putty - Pad	FSP™	3.2mm x 150mm x 175mm	20 Pads	2.58 kg	04584	9.50
AA452	Firestop Putty - Pad	FSP™	6.3mm x 150mm x 175mm	20 Pads	5.44 kg	04522	10.75
AA447	Firestop Putty - Pad	FSP™	6.3mm x 100mm x 200mm	20 Pads	3.63 kg	04478	9.50
Electrical Box Insert – EBI™							
AA0860	Electrical Box Insert - Single	EBI™	6.3mm x 50mm x 100mm	50 Inserts	1.81 kg	08605	P.O.A.
AA0862	Electrical Box Insert - Double	EBI™	6.3mm x 100mm x 100mm	50 Inserts	3.63 kg	08629	19.25
Firestop Pillow – Firestop™							
AA0478	Firestop Pillow™	Firestop	244mm x 100mm x 75mm	20 Pillows	4.54 kg	04782	21.25
AA0479	Firestop Pillow™	Firestop	244mm x 200mm x 75mm	10 Pillows	4.54 kg	04799	26.75
Fire Brick							
AA0834	Fire Brick	NFB	51 mm x 127mm x 203mm	6 Bricks	4.08 kg	08346	47.75
Firestop Cable Coating – FSC™							
AA0671	Cable Coating	FSC™	18.9 l	1 Pail	22.68 kg	06717	521.25
Firestop Compound – CMP™							
AA0476	Firestop Compound	CMP™	22 kg Bag	1 Bag	20.00 kg	04768	144.75
Pipe Choke System – PCS™							
PCS1.5	Pipe Choke System	PCS™	For 40mm O.D.	1 Pipe Choke	.27 kg	05611	24.50
PCS2	Pipe Choke System	PCS™	For 50 mm O.D.	1 Pipe Choke	.36 kg	05628	25.50
PCS3	Pipe Choke System	PCS™	For 75 mm O.D.	1 Pipe Choke	.68 kg	05635	38.50
PCS4	Pipe Choke System	PCS™	For 100 mm O.D.	1 Pipe Choke	1.06 kg	05642	54.25
Wrap Strip System – WRS3™							
AA0896	Wrap Strip	WRS3™	6.3mm x 25.4mm x 3.6 M	1 Strip	12.25 kg	08964	77.75
AA0897	Wrap Strip	WRS3™	6.3mm x 38.1 mm x 3.6 M	1 Strip	6.35 kg	08971	110.75
AA0659D	Wrap Strip Retaining Collar	WRS3™	Small, 25.4mm - 50.8mm	7.62 M / Roll	1.70 kg	06595	94.75
Composite Sheet – CPS™							
AA545	Composite Sheet	CPS™	7.9mm x 61 0mm x 91 0mm	1 Sheet	9.75 kg	05451	415.00
AA546	Composite Sheet	CPS™	7.9mm x 91 0mm x 91 0mm	1 Sheet	14.50 kg	05468	574.50
AA547	Composite Sheet	CPS™	7.9mm x 91 0mm x 1040mm	1 Sheet	15.65 kg	05475	638.50
AA548	Composite Sheet	CPS™	7.9mm x 410mm x 710mm	1 Sheet	5.00 kg	05482	234.00
AA549	Composite Sheet	CPS™	7.9mm x 300mm x 61 0mm	1 Sheet	2.95 kg	05499	170.25
Accessory Products							
AA0401	Ceramic Fibre	Bulk	1 Carton	1 Carton	4.54 kg	04010	72.50
AA0417	Ceramic Fibre	.90 kg Bag	5 Bags per Ctn.	1 Carton	4.54 kg	04171	93.75
AA0457	Mineral Fibre	6.80 kg Bulk	1 Carton	1 Carton	6.80 kg	04577	99.00
AA835	Sausage Pack Gun	Use w/ 597mm F.P.	1 Caulk Gun	1 Per Carton	-	08353	127.50
AA0462	Warning Label		1 Label	1 Per Pack	-	04621	1.25

NELSON

EGS Canada MCT Pricing Information

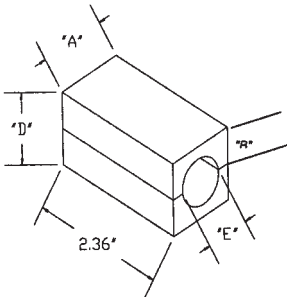
Accessories

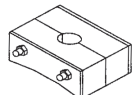
Tecron Insert Blocks For cable, pipe, or conduit	Module 15		Module 20		Module 30		Module 40		Module 60		Module 90		Module 120	
	A = .591" B = .295" D = .591"		A = .787" B = .393" D = .787"		A = 1.181" B = 0.590" D = 1.181"		A = 1.574" B = 0.787" D = 1.574"		A = 2.362" B = 1.181" D = 2.362"		A = 3.543" D = 3.543"		A = 4.724" D = 4.724"	
	Part No.	"E" Inside diam.	Part No.	"E" Inside diam.	Part No.	"E" Inside diam.	Part No.	"E" Inside diam.	Part No.	"E" Inside diam.	Part No.	"E" Inside diam.	Part No.	"E" Inside diam.
	mm	Inch	mm	Inch	mm	Inch	mm	Inch	mm	Inch	mm	Inch	mm	Inch
	15/4	0.157	20/4	0.157	30/11	0.433	40/22	0.866	60/32	1.260	90/50	1.969	120/75	2.953
	15/5	0.197	20/5	0.197	30/12	0.472	40/24	0.945	60/34	1.339	90/55	2.165	120/80	3.150
	15/6	0.236	20/6	0.236	30/13	0.512	40/26	1.024	60/36	1.417	90/60	2.362	120/85	3.346
	15/7	0.276	20/7	0.276	30/14	0.551	40/28	1.102	60/38	1.496	90/65	2.559	120/90	3.543
	15/8	0.315	20/8	0.315	30/15	0.591	40/30	1.181	60/40	1.575	90/70	2.756	120/95	3.740
	15/9	0.354	20/9	0.354	30/16	0.630	40/32	1.260	60/42	1.654				
	15/10	0.394	20/10	0.394	30/17	0.669	40/34	1.339	60/44	1.732				
	15/11	0.433	20/11	0.433	30/18	0.709	40/35	1.378	60/46	1.811				
			20/12	0.472	30/19	0.748			60/48	1.890				
			20/13	0.512	30/20	0.787			60/50	1.969				
			20/14	0.551	30/21	0.827			60/52	2.040				
			20/15	0.591	30/22	0.866			60/54	2.126				
					30/23	0.906			60/55	2.165				
					30/24	0.945								
					30/26	1.024								
List Price		3.90		5.48		8.95		20.90		33.60		79.35		142.50

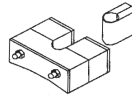
Part Number	Description	Trade \$CAD	Part Number	Description	Trade \$CAD
AA14624	Fill In Strip - 24 x 5/0	15.00	 AA0126112	Compression Plate - Steel	27.00
AA14612	Fill In Strip - 12 x 10/0	17.00	AA0126411	Compression Plate - Aluminium	30.00
 AA0148	Standard End Packing	41.00	AA0126511	Compression Plate - Stainless Steel	113.00
AA0148SS	Standard End Packing - Stainless	66.00	 AA0130U	Stay Plate - Steel	12.00
 AA0147	Special End Packing	66.00	AA0127	Stay Plate - Aluminium	20.00
AA0147SS	Special End Packing - Stainless	82.00	AA0130SS	Stay Plate - Stainless Steel	29.00
AA234	Gasket - 1/8" x 2" x 30"	21.00	AA0239	Wedge Pack - 60mm Stainless Only	275.00
AA235	Gasket - 1/8" x 2-3/8" x 30"	24.00	AA0240	Wedge Pack - 120mm Stainless Only	337.00
			AA0133	Service Part - S.S. Compression Bolt	11.00
			AA0137	Service Part - S.S. Plug	5.00
			AA0099	Service Part - Tallow	6.00

NELSON

EGS Canada Multi Plug Pricing Information

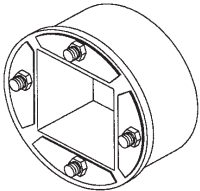
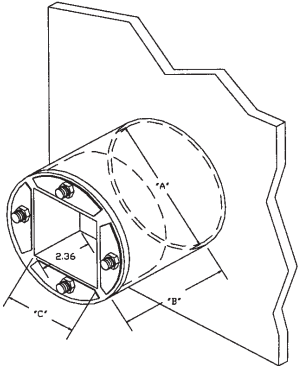
	<i>Part Number</i>	<i>Description</i>	<i>Trade \$CAD</i>
Unsleeved Multi Plug			
	AA0329	Unsleeved Multi Plug MP2-30	65.25
	AA0312	Unsleeved Multi Plug MP3-40	83.50
	AA0307	Unsleeved Multi Plug MP4-60	117.00
	AA0315	Unsleeved Multi Plug MP5-80	126.50
	AA0308	Unsleeved Multi Plug MP6-90	165.75
	AA309	Unsleeved Multi Plug MP8-120	271.00
Sleeved Multi Plug			
	MPSL2-30-4S	Sleeved Multi Plug MP2-30	136.50
	MPSL2-30-12S	Sleeved Multi Plug MP2-30	181.75
	MPSL2-30-4A	Sleeved Multi Plug MP2-30	158.25
	MPSL2-30-12A	Sleeved Multi Plug MP2-30	239.50
	MPSL3-40-4S	Sleeved Multi Plug MP3-40	162.50
	MPSL3-40-12S	Sleeved Multi Plug MP3-40	239.00
	MPSL3-40-4A	Sleeved Multi Plug MP3-40	182.00
	MPSL3-40-12A	Sleeved Multi Plug MP3-40	269.50
	MPSL4-60-4S	Sleeved Multi Plug MP4-60	209.00
	MPSL4-60-12S	Sleeved Multi Plug MP4-60	287.00
	MPSL4-60-4A	Sleeved Multi Plug MP4-60	219.25
	MPSL4-60-12A	Sleeved Multi Plug MP4-60	330.75
	MPSL5-80-4S	Sleeved Multi Plug MP5-80	222.25
	MPSL5-80-12S	Sleeved Multi Plug MP5-80	317.50
	MPSL5-80-4A	Sleeved Multi Plug MP5-80	269.00
	MPSL5-80-12A	Sleeved Multi Plug MP5-80	458.75
	MPSL6-90-4S	Sleeved Multi Plug MP6-90	282.50
	MPSL6-90-12S	Sleeved Multi Plug MP6-90	389.00
	MPSL6-90-4A	Sleeved Multi Plug MP6-90	348.00
	MPSL6-90-12A	Sleeved Multi Plug MP6-90	600.25
	MPSL8-120-4S	Sleeved Multi Plug MP8-120	430.75
	MPSL8-120-12S	Sleeved Multi Plug MP8-120	533.50
	MPSL8-120-4A	Sleeved Multi Plug MP8-120	596.50
	MPSL8-120-12A	Sleeved Multi Plug MP8-120	1,086.25

NELSON

EGS Canada MCT Frame Pricing Information

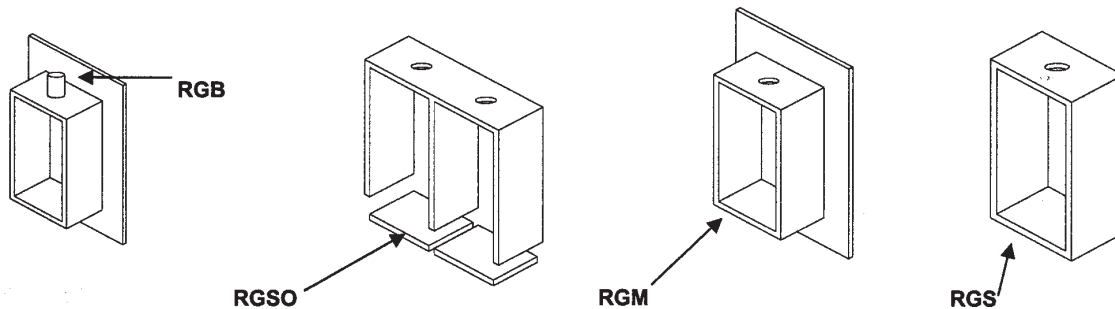

**Due to continuing fluctuations in steel prices
all MCT frames will be quoted on request.**

**Please call customer service at
800-331-7325 for additional accessories**

OFFICES FROM COAST TO COAST

Nelson Firestop Representatives are located throughout Canada to assist you with today's requirements for the electrical industry

	TELEPHONE	FAX
Alberta Industrial: EGS Electrical Group Calgary	403-269-9373	403-253-8901
Edmonton	780-438-8325	780-439-4470
British Columbia Hallwood Milham Technologies Delta BC.	604-526-4288	604-526-1850
Manitoba Isted Technical Sales Winnipeg	204-779-5747	204-779-7307
Newfoundland, New Brunswick, Nova Scotia & P.E.I. Dennis Cummings Lance, NS	902-883-7918	902-883-7698
Ontario Intralec Electrical Products Ltd. Mississauga	905-670-0970	905-670-3098
Quebec Désormeaux Dowd Ltée Montreal Quebec City	514-769-9336 418-627-5465	514-769-9108 418-627-1771
Saskatchewan Isted Technical Sales Regina Saskatoon	306-586-0783 306-242-4641	306-586-5014 306-242-0709

NELSON

99 Union Street, Elmira ON N3B 3L7
Tel: 519-669-9222
Fax: 519-669-6389

EMERSON[™]
Industrial Automation

e-mail: info@egscanada.com

Website: www.egscanada.com